

## Bullet Type LED lamp

BL-L523

### Features:

- Ø 5mm Round-Helmet Type LED Lamp
- Ø Ultra brightness.
- Ø Choice of various viewing angles.
- Ø Diffused, Transparent and Water clear lens are available.
- Ø IC compatible /Low current capability.
- Ø RoHs Compliance



### Electrical-optical characteristics: (Ta=25°C) (Test Condition: IF=20mA)

Part Number	Chip			Lens Type	Forward Voltage(VF) Unit:V		Luminous Intensity (lv) Unit:mcd		Viewing Angle 2θ/2 (deg)
	Emitted Color	Material	λ <sub>p</sub> (nm)		Typ	Max	Min.	Typ.	
					Water Clear	18			
BL-L523SRC	Hi Red	AlGaAs,SH	660		1.85	2.20	100	300	
BL-L523LRC	Super Red	AlGaAs,DH	660		1.85	2.20	300	850	
BL-L523URC	Ultra Red	AlGaAs,DDH	660		1.95	2.20	800	1400	
BL-L523UEC	Ultra Orange	AlGaInP	630		2.10	2.50	900	2400	
BL-L523UYC	Ultra Yellow	AlGaInP	590		2.10	2.50	900	2100	
BL-L523UGC	Ultra Green	AlGaInP	574		2.20	2.50	300	900	
BL-L523PGC	Ultra Pure Green	InGaN	525		3.80	4.50	2000	5000	
BL-L523BGC	Ultra Bluish Green	InGaN	505		3.80	4.50	1800	4000	
BL-L523BC	Blue	InGaN	430		3.80	4.50	1000	2500	
BL-L523UBC	Ultra Blue	InGaN	470		2.70	4.20	2000	5500	
BL-L523VC	UV	InGaN	405		3.80	4.50	90	160	
BL-L523UWC	Ultra White	InGaN	/		2.70	4.20	4500	12000	

### Absolute maximum ratings (Ta=25°C)

Parameter	SR	LR	UR	UE	UY	UG	PG	BG	B	UB	UV	W	Unit
Forward Current I <sub>F</sub>	25	25	25	30	30	30	30	30	30	30	30	30	mA
Power Dissipation P <sub>d</sub>	60	60	60	65	65	75	110	110	120	120	120	120	mW
Reverse Voltage V <sub>R</sub>	5	5	5	5	5	5	5	5	5	5	5	5	V
Peak Forward Current I <sub>PF</sub> (Duty 1/10 @1KHZ)	150	150	150	150	150	150	150	150	100	100	100	100	mA
Operation Temperature T <sub>OPR</sub>	-40 to +80												°C
Storage Temperature T <sub>STG</sub>	-40 to +85												°C
Lead Soldering Temperature T <sub>SOI</sub>	Max.260±5°C for 3 sec Max. (1.6mm from the base of the epoxy bulb)												°C

## Bullet Type LED lamp

BL-L523

### Package configuration & Internal circuit diagram

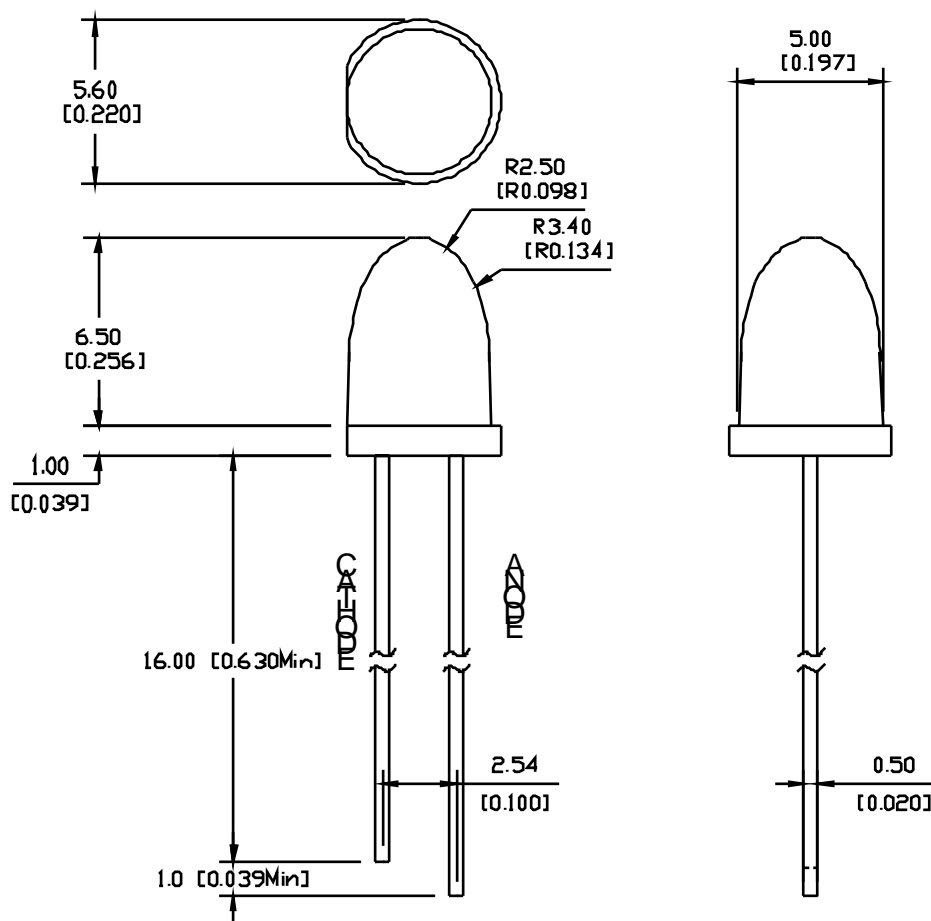

#### Notes:

1. All dimensions are in millimeters (inches)
2. Tolerance is  $\pm 0.25$  (0.01") unless otherwise noted.
3. Specifications are subject to change without notice.

# Bullet Type LED lamp

BL-L523

## Typical electrical-optical characteristics curves:

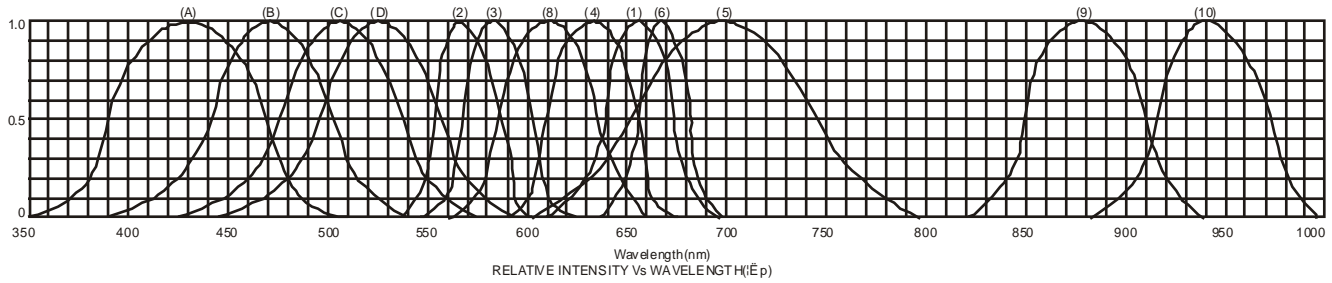

- (1) - GaAsP/GaAs 655nm/Red
- (2) - GaP 570nm/Yellow Green
- (3) - GaAsP/GaP 585nm/Yellow
- (4) - GaAsP/GaP 635nm/Orange & Hi-Eff Red
- (5) - GaP 700nm/Bright Red
- (6) - GaAlAs/GaAs 660nm/Super Red
- (8) - GaAsP/GaP 610nm/Super Red
- (9) - GaAlAs 880nm
- (10) - GaAs/GaAs & GaAlAs/GaAs 940nm
- (A) - GaN/SiC 430nm/Blue
- (B) - InGaN/SiC 470nm/Blue
- (C) - InGaN/SiC 505nm/Ultra Green
- (D) - InGaAlSiC 525nm/Ultra Green

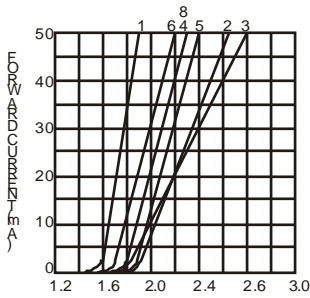

FORWARD VOLTAGE (Vf)  
FORWARD CURRENT VS.  
FORWARD VOLTAGE

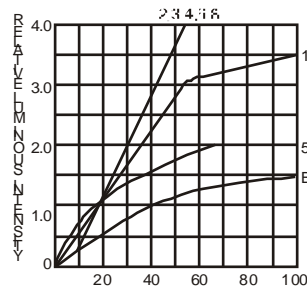

FORWARD CURRENT (mA)  
RELATIVE LUMINOUS  
INTENSITY VS. FORWARD  
CURRENT

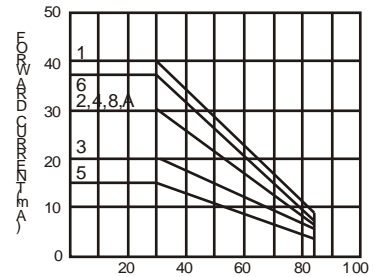

AMBIENT TEMPERATURE Ta( )  
FORWARD CURRENT VS. AMBIENT  
TEMPERATURE



AMBIENT TEMPERATURE Ta( )

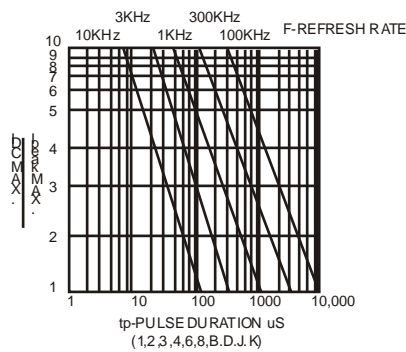

tp-PULSE DURATION µs  
(1,2,3,4,6,8,B,D,J,K)

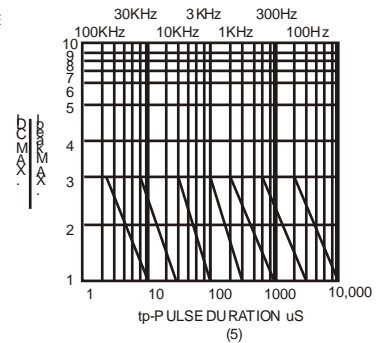

(5)

NOTE:25 free air temperature unless otherwise specified

**Bullet Type LED lamp**

**BL-L523**

**Packing and weighting**

